

European Technical Approval ETA-02/0024

English translation prepared by DIBt - Original version in German language

Handelsbezeichnung
Trade name

Injektionssystem fischer FIS V
Injection System fischer FIS V

Zulassungsinhaber
Holder of approval

fischerwerke GmbH & Co. KG
Otto-Hahn-Straße 15
79211 Denzlingen
DEUTSCHLAND

Zulassungsgegenstand
und Verwendungszweck

*Generic type and use
of construction product*

Verbunddübel in den Größen M6 bis M30 zur Verankerung im
ungerissenen Beton
*Bonded anchor in the size of M6 to M30 for use in non-cracked
concrete*

Geltungsdauer:
Validity:

vom
from
bis
to

12 March 2012

29 October 2012

verlängert
extended

vom
from
bis
to

30 October 2012

30 October 2017

Herstellwerk
Manufacturing plant

fischerwerke

Diese Zulassung umfasst
This Approval contains

38 Seiten einschließlich 29 Anhänge
38 pages including 29 annexes

I LEGAL BASES AND GENERAL CONDITIONS

- 1 This European technical approval is issued by Deutsches Institut für Bautechnik in accordance with:
- Council Directive 89/106/EEC of 21 December 1988 on the approximation of laws, regulations and administrative provisions of Member States relating to construction products¹, modified by Council Directive 93/68/EEC² and Regulation (EC) N° 1882/2003 of the European Parliament and of the Council³;
 - *Gesetz über das In-Verkehr-Bringen von und den freien Warenverkehr mit Bauprodukten zur Umsetzung der Richtlinie 89/106/EWG des Rates vom 21. Dezember 1988 zur Angleichung der Rechts- und Verwaltungsvorschriften der Mitgliedstaaten über Bauprodukte und anderer Rechtsakte der Europäischen Gemeinschaften (Bauproduktengesetz - BauPG) vom 28. April 1998⁴, as amended by Article 2 of the law of 8 November 2011⁵;*
 - Common Procedural Rules for Requesting, Preparing and the Granting of European technical approvals set out in the Annex to Commission Decision 94/23/EC⁶;
 - Guideline for European technical approval of "Metal anchors for use in concrete - Part 5: Bonded anchors", ETAG 001-05.
- 2 Deutsches Institut für Bautechnik is authorized to check whether the provisions of this European technical approval are met. Checking may take place in the manufacturing plant. Nevertheless, the responsibility for the conformity of the products to the European technical approval and for their fitness for the intended use remains with the holder of the European technical approval.
- 3 This European technical approval is not to be transferred to manufacturers or agents of manufacturers other than those indicated on page 1, or manufacturing plants other than those indicated on page 1 of this European technical approval.
- 4 This European technical approval may be withdrawn by Deutsches Institut für Bautechnik, in particular pursuant to information by the Commission according to Article 5(1) of Council Directive 89/106/EEC.
- 5 Reproduction of this European technical approval including transmission by electronic means shall be in full. However, partial reproduction can be made with the written consent of Deutsches Institut für Bautechnik. In this case partial reproduction has to be designated as such. Texts and drawings of advertising brochures shall not contradict or misuse the European technical approval.
- 6 The European technical approval is issued by the approval body in its official language. This version corresponds fully to the version circulated within EOTA. Translations into other languages have to be designated as such.

¹ Official Journal of the European Communities L 40, 11 February 1989, p. 12

² Official Journal of the European Communities L 220, 30 August 1993, p. 1

³ Official Journal of the European Union L 284, 31 October 2003, p. 25

⁴ *Bundesgesetzblatt Teil I 1998*, p. 812

⁵ *Bundesgesetzblatt Teil I 2011*, p. 2178

⁶ Official Journal of the European Communities L 17, 20 January 1994, p. 34

II SPECIFIC CONDITIONS OF THE EUROPEAN TECHNICAL APPROVAL

1 Definition of product/ products and intended use

1.1 Definition of the construction product

The Injection system fischer FIS V is a bonded anchor (injection type) consisting of a mortar cartridge with fischer injection mortar FIS V, FIS VW or FIS VS and a steel element. The steel elements are either

- fischer anchor rods in the range of M6 to M30 or
- fischer internal threaded anchor RG MI in the range of M8 to M20 or
- Reinforcing bar in the range of Ø 8 to Ø 28 or
- fischer rebar anchor FRA in the range of 12 to 24.

The steel element is placed into a drilled hole filled with injection mortar and is anchored via the bond between steel element, injection mortar and concrete.

An illustration of the product and intended use is given in Annexes 1 and 2.

1.2 Intended use

The anchor is intended to be used for anchorages for which requirements for mechanical resistance and stability and safety in use in the sense of the Essential Requirements 1 and 4 of Council Directive 89/106 EEC shall be fulfilled and failure of anchorages made with these products would cause risk to human life and/or lead to considerable economic consequences. Safety in case of fire (Essential Requirement 2) is not covered in this European technical approval. The anchor is to be used only for anchorages subject to static or quasi-static loading in reinforced or unreinforced normal weight concrete of strength classes C20/25 at minimum and C50/60 at most according to EN 206:2000-12.

The anchor may be used in non-cracked concrete only.

The anchor may be installed in dry or wet concrete. The internal threaded anchor RG MI and the fischer-anchor rod in the range of M12 to M30 with coaxial cartridges of sizes 380 ml, 400 ml and 410 ml may be installed in flooded holes excepting sea water.

The drill hole shall be made by hammer drilling or compressed air drilling.

The anchor may be used in the following service temperature ranges:

Temperature range I:	-40 °C to +80 °C	(max long term temperature +50 °C and max short term temperature +80 °C)
Temperature range II:	-40 °C to +120 °C	(max long term temperature +72 °C and max short term temperature +120 °C)

Elements made of zinc coated steel:

The element made of electroplated or hot-dipped galvanised steel may only be used in structures subject to dry internal conditions.

Elements made of stainless steel A4:

The element made of stainless steel may be used in structures subject to dry internal conditions and also in structures subject to external atmospheric exposure (including industrial and marine environment), or exposure in permanently damp internal conditions, if no particular aggressive conditions exist. Such particular aggressive conditions are e.g. permanent, alternating immersion in seawater or the splash zone of seawater, chloride atmosphere of indoor swimming pools or atmosphere with extreme chemical pollution (e.g. in desulphurization plants or road tunnels where de-icing materials are used).

Elements made of high corrosion resistant steel C:

The element made of high corrosion resistant steel may be used in structures subject to dry internal conditions and also in structures subject to external atmospheric exposure, in permanently damp internal conditions or in other particular aggressive conditions. Such particular aggressive conditions are e.g. permanent, alternating immersion in seawater or the splash zone of seawater, chloride atmosphere of indoor swimming pools or atmosphere with chemical pollution (e.g. in desulphurization plants or road tunnels where de-icing materials are used).

Elements made of reinforcing bars:

Post-installed reinforcing bars may only be used as anchors. Such applications are e.g. concrete overlay or shear dowel connections or the connections of a wall predominantly loaded by shear and compression forces with the foundation, where the reinforcing bars act as dowels to take up shear forces. Connections with post-installed reinforcing bars in concrete structures designed in accordance with EN1992-1-1: 2004 are not covered by this European technical approval.

The provisions made in this European technical approval are based on an assumed working life of the anchor of 50 years. The indications given on the working life cannot be interpreted as a guarantee given by the producer, but are to be regarded only as a means for choosing the right products in relation to the expected economically reasonable working life of the works.

2 Characteristics of the product and methods of verification

2.1 Characteristics of product

The anchor corresponds to the drawings and provisions given in Annexes 1 to 7. The characteristic material values, dimensions and tolerances of the anchor not indicated in Annexes 1 to 7 shall correspond to the respective values laid down in the technical documentation⁷ of this European technical approval.

The characteristic anchor values for the design of anchorages are given in Annexes 10 to 29.

The two components of the fischer injection mortar FIS V, FIS VW or FIS VS are delivered in unmixed condition in shuttle cartridges or in coaxial cartridges according to Annex 1. Each cartridge is marked with the imprint "fischer FIS V", "fischer FIS VW" or "fischer FIS VS" with processing notes, shelf life, curing time, processing time (depending on temperature), hazard code.

Each fischer anchor rod is marked with the property class in accordance with Annex 3.

⁷ The technical documentation of this European technical approval is deposited at the Deutsches Institut für Bautechnik and, as far as relevant for the tasks of the approved bodies involved in the attestation of conformity procedure, is handed over to the approved bodies.

Each fischer internal threaded anchor RG MI is marked with the marking of steel grade and length in accordance with Annex 4. Each fischer internal threaded anchor RG MI made of stainless steel is marked with the additional letter "A4". Each fischer internal threaded anchor RG MI made of high corrosion resistant steel is marked with the additional letter "C".

Each fischer rebar anchor FRA is marked with the identifying mark of the producer and the trade name according to Annex 7.

Elements made of reinforcing bars shall comply with the specifications given in Annex 6.

The marking of embedment depth may be done on jobsite.

2.2 Methods of verification

The assessment of fitness of the anchor for the intended use in relation to the requirements for mechanical resistance and stability and safety in use in the sense of the Essential Requirements 1 and 4 has been made in accordance with the "Guideline for European technical approval of Metal Anchors for use in concrete", Part 1 "Anchors in general" and Part 5 "Bonded anchors" on the basis of Option 7.

In addition to the specific clauses relating to dangerous substances contained in this European technical approval, there may be other requirements applicable to the products falling within its scope (e.g. transposed European legislation and national laws, regulations and administrative provisions). In order to meet the provisions of the Construction Products Directive, these requirements need also to be complied with, when and where they apply.

3 Evaluation and attestation of conformity and CE marking

3.1 System of attestation of conformity

According to the Decision 96/582/EG of the European Commission⁸ system 2(i) (referred to as System 1) of the attestation of conformity applies.

This system of attestation of conformity is defined as follows:

System 1: Certification of the conformity of the product by an approved certification body on the basis of:

- (a) Tasks for the manufacturer:
 - (1) factory production control;
 - (2) further testing of samples taken at the factory by the manufacturer in accordance with a prescribed control plan;
- (b) Tasks for the approved body:
 - (3) initial type-testing of the product;
 - (4) initial inspection of factory and of factory production control;
 - (5) continuous surveillance, assessment and approval of factory production control.

Note: Approved bodies are also referred to as "notified bodies".

⁸ Official Journal of the European Communities L 254 of 08.10.1996

3.2 Responsibilities

3.2.1 Tasks for the manufacturer

3.2.1.1 Factory production control

The manufacturer shall exercise permanent internal control of production. All the elements, requirements and provisions adopted by the manufacturer shall be documented in a systematic manner in the form of written policies and procedures, including records of results performed. This production control system shall insure that the product is in conformity with this European technical approval.

The manufacturer may only use initial/raw/constituent materials stated in the technical documentation of this European technical approval.

The factory production control shall be in accordance with the control plan which is part of the technical documentation of this European technical approval. The control plan is laid down in the context of the factory production control system operated by the manufacturer and deposited with Deutsches Institut für Bautechnik.⁹

The results of factory production control shall be recorded and evaluated in accordance with the provisions of the control plan.

3.2.1.2 Other tasks for the manufacturer

The manufacturer shall, on the basis of a contract, involve a body which is approved for the tasks referred to in section 3.1 in the field of anchors in order to undertake the actions laid down in section 3.2.2 For this purpose, the control plan referred to in sections 3.2.1.1 and 3.2.2 shall be handed over by the manufacturer to the approved body involved.

The manufacturer shall make a declaration of conformity, stating that the construction product is in conformity with the provisions of this European technical approval.

3.2.2 Tasks for the approved bodies

The approved body shall perform the

- initial type-testing of the product,
- initial inspection of factory and of factory production control,
- continuous surveillance, assessment and approval of factory production control,

in accordance with the provisions laid down in the control plan.

The approved body shall retain the essential points of its actions referred to above and state the results obtained and conclusions drawn in a written report.

The approved certification body involved by the manufacturer shall issue an EC certificate of conformity of the product stating the conformity with the provisions of this European technical approval.

In cases where the provisions of the European technical approval and its control plan are no longer fulfilled the certification body shall withdraw the certificate of conformity and inform Deutsches Institut für Bautechnik without delay.

3.3 CE marking

The CE marking shall be affixed on each packaging of the anchor. The letters "CE" shall be followed by the identification number of the approved certification body, where relevant, and be accompanied by the following additional information:

- the name and address of the producer (legal entity responsible for the manufacture),
- the last two digits of the year in which the CE marking was affixed,

⁹ The control plan is a confidential part of the European technical approval and only handed over to the approved body involved in the procedure of attestation of conformity. See section 3.2.2.

- the number of the EC certificate of conformity for the product,
- the number of the European technical approval,
- the number of the guideline for European technical approval,
- use category (ETAG 001-1, Option 7),
- size.

4 Assumptions under which the fitness of the product for the intended use was favourably assessed

4.1 Manufacturing

The European technical approval is issued for the product on the basis of agreed data/information, deposited with Deutsches Institut für Bautechnik, which identifies the product that has been assessed and judged. Changes to the product or production process, which could result in this deposited data/information being incorrect, should be notified to Deutsches Institut für Bautechnik before the changes are introduced. Deutsches Institut für Bautechnik will decide whether or not such changes affect the approval and consequently the validity of the CE marking on the basis of the approval and if so whether further assessment or alterations to the approval shall be necessary.

4.2 Design of anchorages

The fitness of the anchor for the intended use is given under the following conditions:

The anchorages are designed in accordance with the

- EOTA Technical Report TR 029 "Design of bonded anchors"¹⁰

or in accordance with the

- CEN/TS 1992-4-5 "Design of fastenings for use in concrete", Part 4-5: "Post-installed fasteners - Chemical systems",

under the responsibility of an engineer experienced in anchorages and concrete work.

Post-installed reinforcing bars may only be used as anchors. The basic assumptions for the design according to anchor theory shall be observed. This includes the consideration of tension and shear loads and the corresponding failure modes as well as the assumption that the base material (concrete structural element) remains essentially in the serviceability limit state (either non-cracked or cracked) when the connection is loaded to failure. Such applications are e.g. concrete overlay or shear dowel connections or the connections of a wall predominantly loaded by shear and compression forces with the foundation, where the reinforcing bars act as dowels to take up shear forces. Connections with reinforcing bars in concrete structures designed in accordance with EN 1992-1-1:2004 (e.g. connection of a wall loaded with tension forces in one layer of the reinforcement with the foundation) are not covered by this European technical approval.

For the fischer internal threaded anchor RG MI fastening screws or threaded rods made of appropriate steel and strength class acc. to Annex 5 shall be specified. The minimum and maximum thread engagement length l_E of the fastening screw or the threaded rod for installation of the fixture shall be met the requirements according to Annex 4, Table 2. The length of the fastening screw or the threaded rod shall be determined depending on thickness of fixture, admissible tolerances, available thread length and minimum and maximum thread engagement length l_E .

¹⁰ The Technical Report TR 029 "Design of Bonded Anchors" is published in English on EOTA website www.eota.eu.

Verifiable calculation notes and drawings are prepared taking account of the loads to be anchored.

The position of the anchor is indicated on the design drawings (e.g. position of the anchor relative to reinforcement or to supports, etc.).

4.3 Installation of anchors

The fitness for use of the anchor can only be assumed if the anchor is installed as follows:

- anchor installation carried out by appropriately qualified personnel and under the supervision of the person responsible for technical matters of the site,
- use of the anchor only as supplied by the manufacturer without exchanging the components of an anchor,
- anchor installation in accordance with the manufacturer's specifications and drawings using the tools indicated in the technical documentation of this European technical approval,
- commercial standard threaded rods, washers and hexagon nuts may also be used if the following requirements are fulfilled:
 - material, dimensions and mechanical properties of the metal parts according to the specifications given in Annex 5, Table 3,
 - confirmation of material and mechanical properties of the metal parts by inspection certificate 3.1 according to EN 10204:2004, the documents should be stored,
 - marking of the threaded rod with the envisage embedment depth. This may be done by the manufacturer of the rod or the person on jobsite.
- reinforcing bars shall comply with specifications given in Annex 6,
- checks before placing the anchor to ensure that the strength class of the concrete in which the anchor is to be placed is in the range given and is not lower than that of the concrete to which the characteristic loads apply,
- check of concrete being well compacted, e.g. without significant voids,
- marking and keeping the effective anchorage depth,
- edge distance and spacing not less than the specified values without minus tolerances,
- positioning of the drill holes without damaging the reinforcement,
- drilling by hammer drilling or compressed air drilling,
- in case of aborted drill hole: the drill hole shall be filled with mortar,
- The anchor may be installed in dry or wet concrete. The internal threaded anchor RG MI and the fischer-anchor rod in the range of M12 to M30 with coaxial cartridges of sizes 380 ml, 400 ml and 410 ml may be installed in flooded holes excepting sea water,
- cleaning the drill hole and installation in accordance with Annexes 8 and 9,
- the anchor component installation temperature shall be at least 0 °C (fischer FIS VW) and +5 °C (FIS V and FIS VS); during curing of the chemical mortar the temperature of the concrete must not fall below -5 °C (fischer FIS V, FIS VW) and 0 °C (FIS VS); observing the curing time according to Annex 5, Table 4 until the anchor may be loaded,
- for installation in bore holes $h_0 > 150$ mm extension hoses acc. Annex 1 shall be used,
- Fastening screw or threaded rods (including nut and washer) must comply with the appropriate material and strength class of the fischer internal threaded anchor RG MI,
- installation torque moments are not required for functioning of the anchor. However, the torque moments given in Annexes 3 to 7 must not be exceeded.

5 Indications to the manufacture

5.1 Responsibility of the manufacturer

It is in the responsibility of the manufacturer to ensure that the information on the specific conditions according to 1 and 2 including Annexes referred to as well as sections 4.2, 4.3 and 5.2 is given to those who are concerned. This information may be made by reproduction of the respective parts of the European technical approval. In addition all installation data shall be shown clearly on the package and/or on an enclosed instruction sheet, preferably using illustration(s).

The minimum data required are:

- drill bit,
- hole depth,
- diameter of anchor rod,
- minimum effective anchorage depth,
- information on the installation procedure, including cleaning of the hole with the cleaning equipments, preferably by means of an illustration,
- anchor component installation temperature,
- material and property class of metal parts acc. to Annex 5, Table 3,
- ambient temperature of the concrete during installation of the anchor,
- admissible processing time (open time) of a cartridge,
- curing time until the anchor may be loaded as a function of the ambient temperature in the concrete during installation,
- maximum torque moment,
- identification of the manufacturing batch.

All data shall be presented in a clear and explicit form.

5.2 Recommendations concerning packaging, transport and storage

The injection cartridges shall be protected against sun radiation and shall be stored according to the manufacture's installation instructions in dry condition at temperatures of at least +5 °C to not more than +25 °C.

Mortar cartridges with expired shelf life must no longer be used.

The anchor shall only be packaged and supplied as a complete unit. Mortar cartridges may be packed separately from metal parts.

Georg Feistel
Head of Department

beglaubigt:
Aksünger

English translation prepared by DIBt

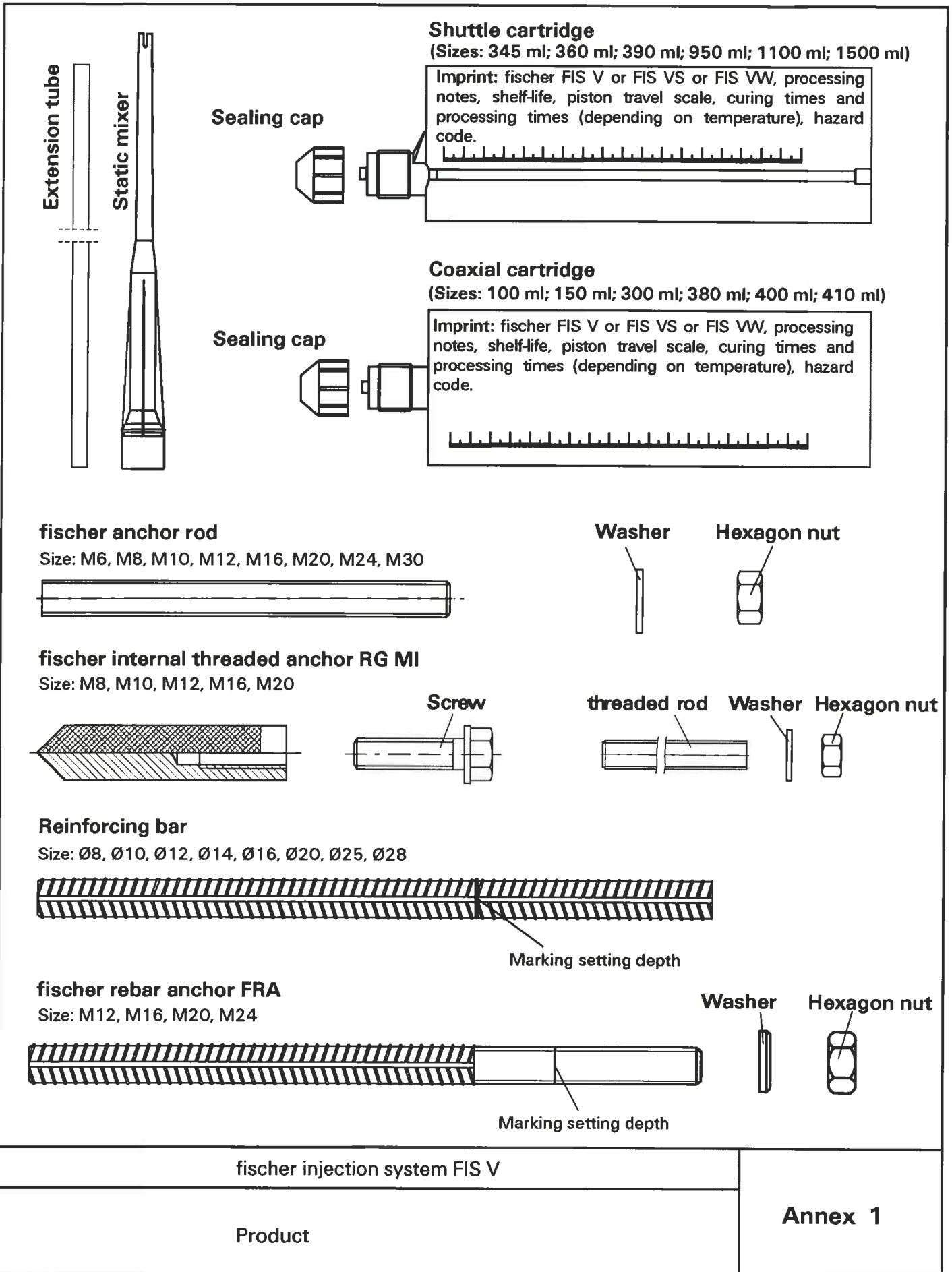

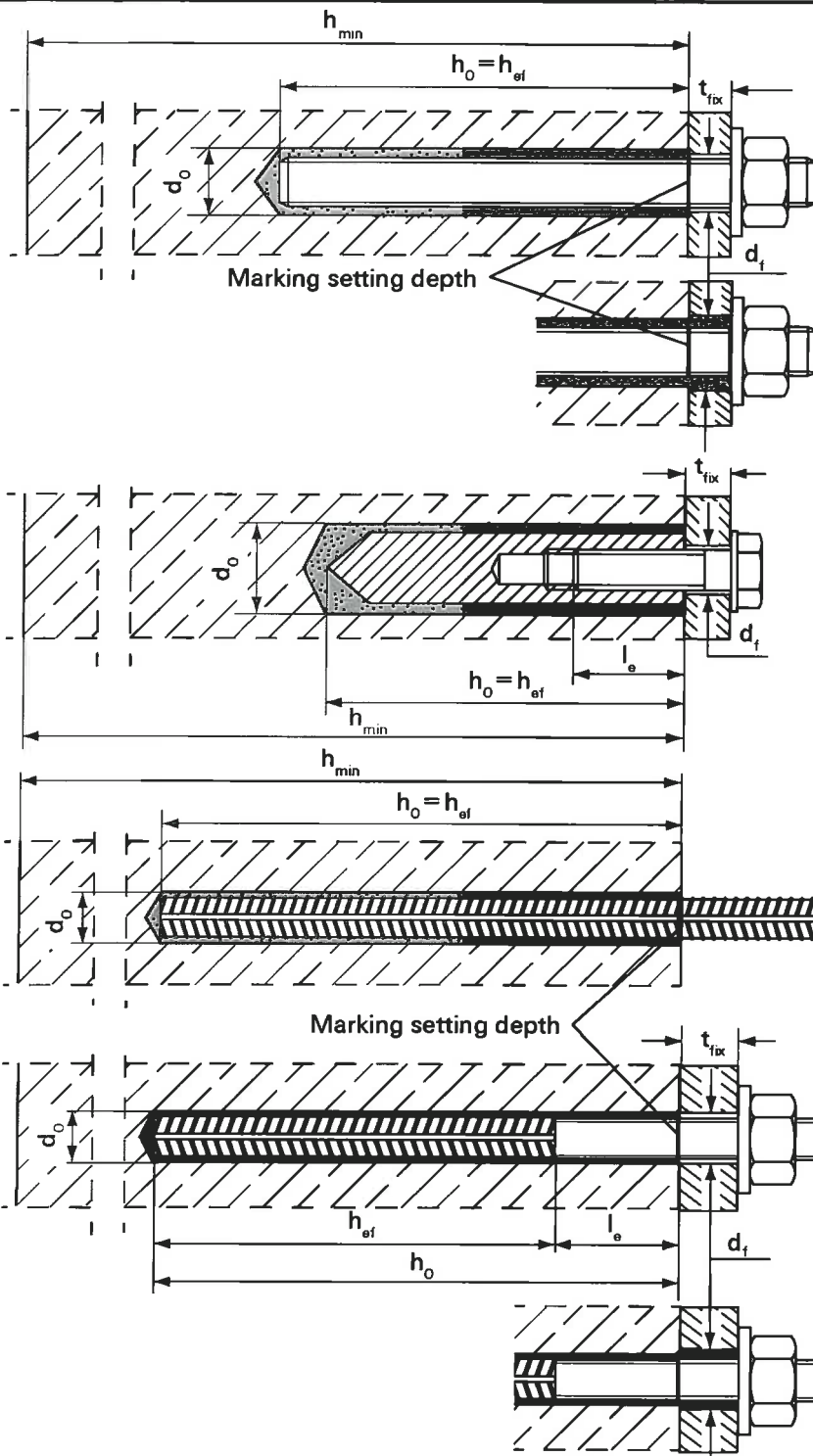

fischer anchor rod
Pre-positioned anchorage

push-through anchorage
(annular clearance filled
with mortar)

**fischer internal threaded anchor
RG MI**
Only pre-positioned anchorage

Reinforcing bar

**fischer
rebar anchor FRA**
Pre-positioned anchorage

Push-through anchorage
(annular clearance filled
with mortar)

fischer injection system FIS V

Intended Use

Annex 2

Table 1: Installation parameters fischer anchor rods

Size of anchor	[-]	M6	M8	M10	M12	M16	M20	M24	M30
Nominal drill bit diameter	d_o [mm]	8	10	12	14	18	24	28	35
Drill hole depth	h_o [mm]	$h_o = h_{ef}$							
Effective anchorage depth	$h_{ef,min}$ [mm]	50	60	60	70	80	90	96	120
	$h_{ef,max}$ [mm]	72	160	200	240	320	400	480	600
Minimum spacing and minimum edge distance	$s_{min} = c_{min}$ [mm]	40	40	45	55	65	85	105	140
Diameter of clearance hole in the fixture ¹⁾	pre-positioned anchorage d_f [mm]	7	9	12	14	18	22	26	33
	push-through anchorage d_i [mm]	9	11	14	16	20	26	30	40
Minimum thickness of concrete member	h_{min} [mm]	$h_{ef} + 30 (\geq 100)$				$h_{ef} + 2d_o$			
Maximum torque moment	$T_{inst,max}$ [Nm]	5	10	20	40	60	120	150	300
Thickness of fixture	$t_{fix,min}$ [mm]	0							
	$t_{fix,max}$ [mm]	3000							

¹⁾For bigger clearance holes in fixture see chapter 1.1 of the TR 029.

fischer anchor rod

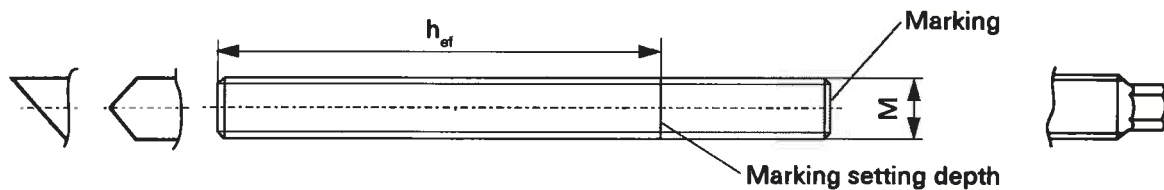

Marking:

- Property class 8.8 or high corrosion-resistant steel C, property class 80: •
- Stainless steel A4, property class 50 and high corrosion-resistant steel C, property class 50: ••

Application range and intended use

	max. long term temperature	max. short term temperature
Temperature range I: -40°C to +80°C	+50°C	+80°C
Temperature range II: -40°C to +120°C	+72°C	+120°C
Intended use	dry concrete	wet concrete
Anchor rods	M8 – M30	
Internal threaded anchors RG MI	M8 – M20	
	flooded hole ¹⁾	
	M12 – M30	

¹⁾Only coaxial cartridge 380 ml, 400 ml and 410 ml.

fischer injection system FIS V	Annex 3
fischer anchor rods	
Installation parameters and dimensions Application range and intended use	

Table 2: Installation parameters for fischer internal threaded anchors RG MI

Size of anchor		M8	M10	M12	M16	M20
Diameter of anchor	d_H [mm]	12	16	18	22	28
Nominal drill bit diameter	d_o [mm]	14	18	20	24	32
Length of anchor	L_H [mm]	90	90	125	160	200
Effective anchorage depth h_{ef} and drill hole depth h_o	$h_{ef} = h_o$ [mm]	90	90	125	160	200
Minimum spacing and edge distance	$s_{min} = c_{min}$ [mm]	55	65	75	95	125
Diameter of clearance hole in the fixture	d_f [mm]	9	12	14	18	22
Minimum thickness of concrete member	h_{min} [mm]	120	125	165	205	260
Screw-in depth	$l_{E,min}$ [mm]	8	10	12	16	20
	$l_{E,max}$ [mm]	18	23	26	35	45
Maximum troque moment	$T_{inst,max}$ [Nm]	10	20	40	80	120

fischer internal threaded anchor RG MI

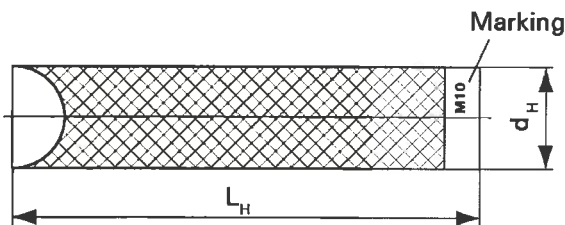
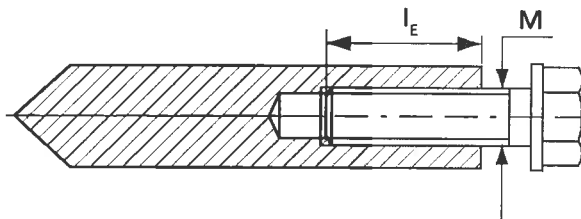

Marking: anchor size
e.g.: M10
Stainless steel additional A4
e.g.: M10 A4
High corrosion-resistant steel additional C
e.g.: M10 C

fischer injection system FIS V

fischer internal threaded anchors RG MI
Installation parameters and dimensions

Annex 4

English translation prepared by DIBt

Table 3: Materials: anchor rods, washers, hexagon nuts and screws

Designation	Materials		
	Steel, zinc plated	Stainless steel A4	high corrosion-resistant steel C
anchor rod	Property class 5.8 or 8.8; EN ISO 898-1 zinc plated $\geq 5\mu\text{m}$, EN ISO 4042 A2K or hot-dip galvanised EN ISO 10684 $f_{uk} \leq 1000 \text{ N/mm}^2$ $A_b > 8\%$	Property class 50, 70 or 80 EN ISO 3506 1.4401; 1.4404; 1.4578; 1.4571; 1.4439; 1.4362 EN 10088 or 1.4062 pr EN 10088:2011 $f_{uk} \leq 1000 \text{ N/mm}^2$ $A_b > 8\%$	Property class 50 or 80 EN ISO 3506 or property class 70 with $f_{yk} = 560 \text{ N/mm}^2$ 1.4565; 1.4529 EN 10088 $f_{uk} \leq 1000 \text{ N/mm}^2$ $A_b > 8\%$
Washer EN ISO 7089	zinc plated $\geq 5\mu\text{m}$, EN ISO 4042 A2K or hot-dip galvanised EN ISO 10684	1.4401; 1.4404; 1.4578; 1.4571; 1.4439; 1.4362 EN 10088	1.4565; 1.4529 EN 10088
Hexagon nut according to EN ISO 4032	Property class 5 or 8; EN ISO 898-2 zinc plated $\geq 5\mu\text{m}$, EN ISO 4042 A2K or hot-dip galvanised EN ISO 10684	Property class 50, 70 or 80 EN ISO 3506 1.4401; 1.4404; 1.4578; 1.4571; 1.4439; 1.4362 EN 10088	Property class 50, 70 or 80 EN ISO 3506 1.4565; 1.4529 EN 10088
Screw or anchor rods for internal- threaded anchors RG MI	Property class 5.8 or 8.8; EN ISO 898-1 zinc plated $\geq 5\mu\text{m}$, EN ISO 4042 A2K or hot-dip galvanised EN ISO 10684	Property class 70 EN ISO 3506 1.4401; 1.4404; 1.4578; 1.4571; 1.4439; 1.4362 EN 10088	Property class 70 EN ISO 3506-1 1.4565; 1.4529 EN 10088

Table 4: Maximum processing time of the mortar and minimum curing time

(During the curing time of the mortar the concrete temperature may not fall below the listed minimum temperature).

Temperature at anchoring base [°C]	Minimum curing time ¹⁾ t_{cure} [minutes]			System- temperature (mortar) [°C]	Maximum processing time t_{work} [minutes]		
	FIS VW	FIS V	FIS VS		FIS VW	FIS V	FIS VS
-5 to ± 0	3 hours	24 hours	—	0	5	—	—
≥ 0 to +5	3 hours	3 hours	6 hours	+ 5	5	13	—
>+5 to +10	50	90	3 hours	+ 10	3	9	20
>+10 to +20	30	60	2 hours	+ 20	1	5	10
>+20 to +30	—	45	60	+ 30	—	4	6
>+30 to +40	—	35	30	+ 40	—	2	4

¹⁾ For wet concrete the curing time must be doubled.

fischer injection system FIS V

Materials
Processing time and curing time

Annex 5

English translation prepared by DIBt

Table 5: Installation parameters reinforcing bars

Rebar diameter	d [mm]	8 ¹⁾	10 ¹⁾	12 ¹⁾	14	16	20	25	28
Nominal drill bit diameter	d ₀ [mm]	(10)12	(12)14	(14)16	18	20	25	30	35
Drill hole depth	h ₀ [mm]	h ₀ = h _{ef}							
Effective anchorage depth	h _{ef,min} [mm]	60	60	70	75	80	90	100	112
	h _{ef,max} [mm]	160	200	240	280	320	400	500	560
Minimum spacing and minimum edge distance	s _{min} = c _{min} [mm]	40	45	55	60	65	85	110	130
Minimum thickness of concrete member	h _{min} [mm]	h _{ef} + 30 ≥ 100			h _{ef} + 2d ₀				

¹⁾ Both drill bit diameters can be used

Reinforcing bar

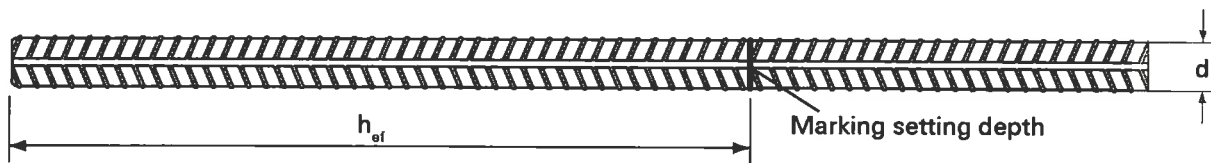

Properties of reinforcement: refer to EN 1992-1-1 Annex C, Table C.1 and C.2N

Produkt form	Non-zinc-plated bars and de-coiled rod	
Class	B	C
Characteristic yield strength f _{yk} or f _{0,2k} [MPa]	400 to 600	
Minimum value of k = (f _t / f _{yk})	≥ 1,08	≥ 1,15 < 1,35
Characteristic strain at maximum force ε _{uk} [%]	≥ 5,0	≥ 7,5
Bendability property	Bend / Rebendtest	
Maximum deviation from nominal mass (individual bar) [%]	Nominal bar size [mm] ≤ 8 > 8	± 6,0 ± 4,5
Bond: Minimum relative rib area, f _{R,min} (determination according to EN 15630)	Nominal bar size [mm] 8 to 12 > 12	0,040 0,056

Rib height h: The rib height h must be: $0,05 \cdot d \leq h \leq 0,07 \cdot d$ d = nominal bar size

fischer injection system FIS V

Reinforcing bars
Installation parameters
Materials

Annex 6

Table 6: Installation parameters fischer rebar anchors FRA

Threaded diameter		M 12 ¹⁾	M 16	M 20	M 24
Nominal bar size	d [mm]	12	16	20	25
Nominal drill bit diameter	d _o [mm]	(14) 16	20	25	30
Drill hole depth (h _o =ℓ _{e,ges})	h _o [mm]	h _{ef} +ℓ _e			
Effective anchorage depth	h _{ef,min} [mm]	70	80	90	96
	h _{ef,max} [mm]	140	220	300	380
Distance concrete surface to welded joint	ℓ _e [mm]	100			
Minimum spacing and minimum edge distance	s _{min} =c _{min} [mm]	55	65	85	105
Clearance hole in the fixture ²⁾	pre-positioned anchorage d _f [mm]	14	18	22	26
	push-through anchorage d _f [mm]	18	22	26	32
Minimum thickness of concrete member	h _{min} [mm]	h _{ef} +30 ≥ 100	h _o +2d _o		
Maximum torque moment	T _{inst,max} [Nm]	40	60	120	150
Thickness of fixture	minimum t _{fix} [mm]	0			
	maximum t _{fix} [mm]	3000			

¹⁾ Both drill bit diameter can be used

²⁾ For bigger clearance holes in the fixture see chapter 1.1 of the TR 029.

fischer rebar anchor FRA

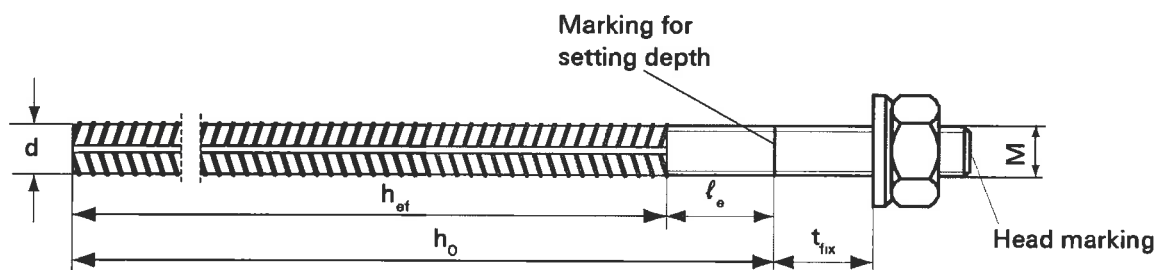

Head marking e.g.:  FRA (for stainless steel);

 FRA C (for high corrosion-resistant steel)

fischer injection system FIS V

fischer rebar anchor FRA
Installation Parameters

Annex 7

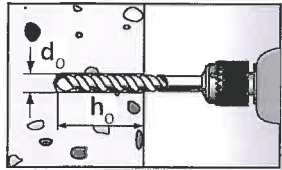

Drilling and cleaning the hole

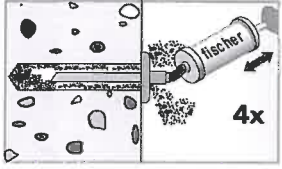
1  Drill the hole.
Drill hole diameter d_0 and drill hole depth h_0
see Table 1.

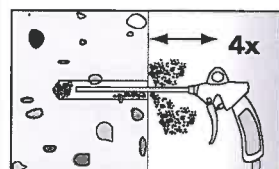
2  $h_{ef} \leq 12d; d_0 < 18\text{mm}$:
Blow out the drill hole
four times
by hand.

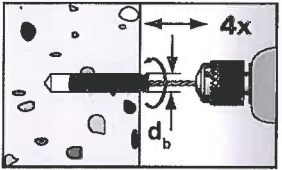
 $h_{ef} > 12d; d_0 \geq 18\text{mm}$:
Blow out the drill hole
four times, using oil-free
pressure air ($p > 6\text{ bar}$).

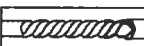
3  Brush the drill hole four times using a adequate steel brush and a drill machine. For deep drill holes use an extension.

	d_0 [mm]	8	10	12	14	16	18	20	24	25	28	30	35
	d_b [mm]	9	11	14	16	20	20	25	26	27	30	40	40

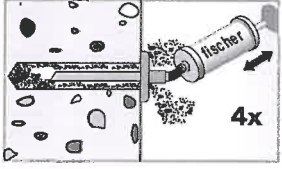
4  $h_{ef} \leq 12d; d_0 < 18\text{mm}$:
Blow out the drill hole
four times
by hand.

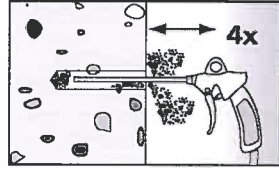
 $h_{ef} > 12d; d_0 \geq 18\text{mm}$:
Blow out the drill hole
four times, using oil-free
pressure air ($p > 6\text{ bar}$).

Preparing the cartridge

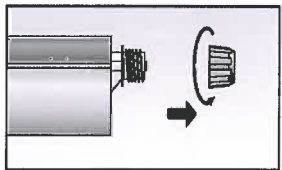
5  Twist off the sealing cap.

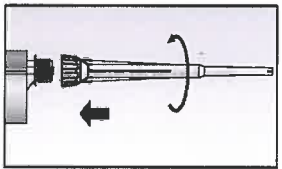
6  Twist on the mixing nozzle
(the spiral in the mixing
nozzle must be clearly
visible).

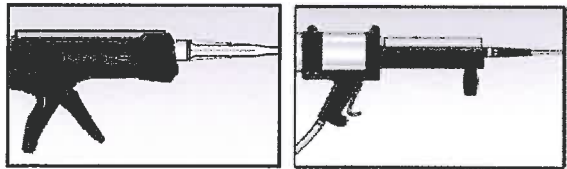
7  Place the cartridge into
the dispenser.

8  Press out approx. 10 cm of mortar
until the resin is permanent grey in colour.
Don` t use uniformly grey unreal mortar.

fischer injection system FIS V

Installation instructions
Part 1

Annex 8

English translation prepared by DIBt

Injection of the mortar

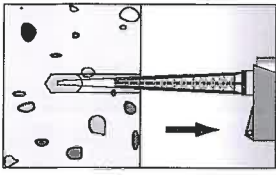
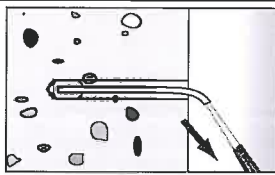
9		<p>Fill approx. 2/3 of the drill hole with mortar. Always begin from the bottom of the hole to eliminate voids.</p>		<p>For drill hole depth ≥ 150 mm use an extension tube.</p>
----------	---	---	--	---

Installation fischer anchor rods or internal threaded anchors RG MI

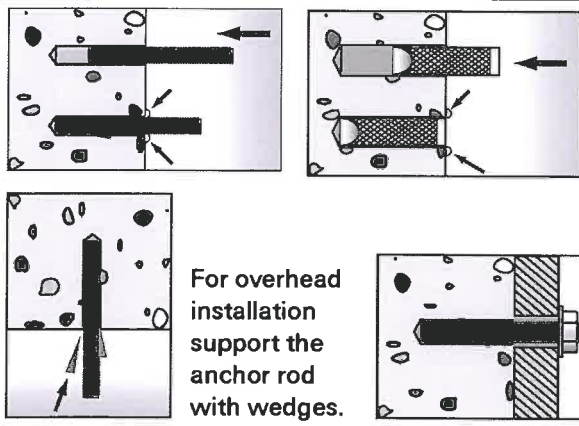
10		<p>Only use clean and oil-free anchor elements. Mark the anchor element for setting depth. Press the anchor rod or internal threaded anchor down to the bottom of the hole, turning it slightly while doing so. After inserting the anchor element, excess mortar must emerge around the anchor element.</p>
	<p>For overhead installation support the anchor rod with wedges.</p>	<p>For push-through installation fill the annular gap with mortar.</p>

11		<p>Wait for the specified curing time. t_{cure} see Table 4.</p>
-----------	--	--

12		<p>Mounting the fixture $T_{\text{inst,max}}$ see Table 1 or 2.</p>
-----------	---	--

Installation reinforcing bars and fischer rebar anchors FRA

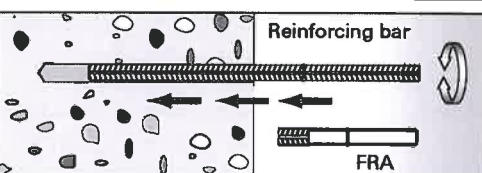
10		<p>Only use clean and oil-free rebars. Mark the reinforcing bar for setting depth. Using a turning movement, push the reinforcing bar or the FRA vigorously into the filled hole up to the insertion depth marking. When reaching the setting depth marking surplus mortar must emerge around the anchor.</p>
-----------	---	---

11		<p>Wait for the specified curing time. t_{cure} see Table 4.</p>
-----------	---	--

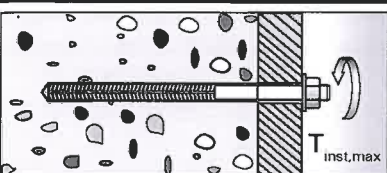
12		<p>Mounting the fixture $T_{\text{inst,max}}$ see Table 6.</p>
-----------	---	---

fischer injection system FIS V

Installation instructions
Part 2

Annex 9

Table 7: Design of Bonded Anchors acc. to TR 029
Characteristic values to tension load for fischer anchor rods

Size		M 6	M 8	M 10	M 12	M 16	M 20	M 24	M 30		
Steel failure											
Characteristic resistance $N_{Rk,s}$	Property class	5.8 [kN]	11	19	29	43	79	123	177	281	
		8.8 [kN]	16	30	47	68	126	196	282	449	
	stainless steel A4 and steel C	Property class	50 [kN]	11	19	29	43	79	123	177	281
			70 [kN]	14	26	41	59	110	172	247	393
			80 [kN]	16	30	47	68	126	196	282	449
Partial safety factor $\gamma_{Ms,N}^{1)}$	Property class	5.8 [-]	1,50								
		8.8 [-]	1,50								
	stainless steel A4 and steel C	Property class	50 [-]	2,86							
			70 [-]	1,50 ³⁾ /1,87							
			80 [-]	1,60							
Combined pullout and concrete cone failure											
Diameter of calculation	d [mm]	6	8	10	12	16	20	24	30		
Characteristic bond resistance in concrete C20/25											
Intended use: dry and wet concrete											
Temperature range I ⁴⁾	$\tau_{Rk,ucr}$ [N/mm ²]	9	11	11	11	10	9,5	9,0	8,5		
Temperature range II ⁴⁾	$\tau_{Rk,ucr}$ [N/mm ²]	6,5	9,5	9,5	9,0	8,5	8,0	7,5	7,0		
Characteristic bond resistance in concrete C20/25											
Intended use: flooded hole⁶⁾											
Temperature range I ⁴⁾	$\tau_{Rk,ucr}$ [N/mm ²]	—	—	—	9,5	8,5	8,0	7,5	7,0		
Temperature range II ⁴⁾	$\tau_{Rk,ucr}$ [N/mm ²]	—	—	—	7,5	7,0	6,5	6,0	6,0		
Increasing factors for $\tau_{Rk,ucr}$	ψ_c	C25/30 [-]	1,05								
		C30/37 [-]	1,10								
		C35/45 [-]	1,15								
		C40/50 [-]	1,19								
		C45/55 [-]	1,22								
		C50/60 [-]	1,26								
Splitting failure											
Edge distance $C_{cr,sp}$ [mm]	$h / h_{ef} \geq 2,0$	1,0 h_{ef}									
	$2,0 > h / h_{ef} > 1,3$	4,6 h_{ef} - 1,8 h									
	$h / h_{ef} \leq 1,3$	2,26 h_{ef}									
Spacing	$s_{cr,sp}$ [mm]	2 $c_{cr,sp}$									
Partial safety factor $\gamma_{MP} = \gamma_{MC} = \gamma_{Msp}^{1)}$ [-]	dry and wet	1,5 ²⁾									
	flooded hole ⁶⁾	1,8 ⁵⁾									

¹⁾In absence of other national regulations

²⁾The partial factor $\gamma_2 = 1,0$ is included

³⁾For steel C: $f_{uk} = 700$ N/mm²; $f_{yk} = 560$ N/mm²

⁴⁾See Annex 2

⁵⁾The partial factor $\gamma_2 = 1,2$ is included

⁶⁾Only for coaxial cartridge 380ml, 400ml and 410ml

fischer Injections system FIS V

Design of Bonded Anchors acc. to TR 029
fischer anchor rods
Characteristic values to tension load

Annex 10

Table 8: Design of Bonded Anchors acc. to TR 029
Characteristic values to shear load fisher anchor rods

Size		M6	M8	M10	M12	M16	M20	M24	M30		
Steel failure without lever arm											
Characteristic resistance $V_{Rk,s}$	Property class	5.8 [kN]	5	9	15	21	39	61	89	141	
		8.8 [kN]	8	15	23	34	63	98	141	225	
	stainless steel A4 and steel C	Property class	50 [kN]	5	9	15	21	39	61	89	141
			70 [kN]	7	13	20	30	55	86	124	197
		80 [kN]	8	15	23	34	63	98	141	225	
Steel failure with lever arm											
Characteristic bending moment $M_{Rk,s}^0$	Property class	5.8 [Nm]	8	19	37	65	166	324	561	1124	
		8.8 [Nm]	12	30	60	105	266	519	898	1799	
	stainless steel A4 and steel C	Property class	50 [Nm]	8	19	37	65	166	324	561	1124
			70 [Nm]	11	26	52	92	233	454	785	1574
		80 [Nm]	12	30	60	105	266	519	898	1799	
Partial safety factor steel failure											
$\gamma_{Ms,V}^{1)}$	Property class	5.8 [-]								1,25	
		8.8 [-]								1,25	
	stainless steel A4 and steel C	Property class	50 [-]								2,38
			70 [-]								1,25 ³⁾ / 1,56
		80 [-]								1,33	
Concrete pryout failure											
Factor k in Equation (5.7) of Technical Report TR 029 Section 5.2.3.3		k [-]								2,0	
Partial safety failure		$\gamma_{Mcp}^{1)}$ [-]								1,5 ²⁾	
Concrete edge failure											
Partial safety failure		$\gamma_{Mc}^{1)}$ [-]								1,5 ²⁾	

¹⁾ In absence of other national regulations.

²⁾ The partial safety factor $\gamma_2 = 1,0$ is included.

³⁾ For steel C: $f_{uk} = 700 \text{ N/mm}^2$; $f_{yk} = 560 \text{ N/mm}^2$

fischer injection system FIS V

Design of Bonded Anchors acc. to TR 029
fischer anchor rods
Characteristic values to shear load

Annex 11

English translation prepared by DIBt

Table 9: Displacements of fischer anchor rods to tension load

Size		M6	M8	M10	M12	M16	M20	M24	M30
Temperature range I -40°C / +80°C		Effective anchorage depth $h_{ef} = 8 d^{1)}$							
Tension load	N [kN]	2,5	7,7	11,0	15,8	25,5	37,9	51,7	76,3
Displacement	δ_{NO} [mm]	0,1	0,2	0,2	0,2	0,2	0,3	0,3	0,3
Displacement	δ_{Nz} [mm]	0,3	0,6	0,6	0,6	0,6	0,9	0,9	0,9
Temperature range II -40°C / +120°C		Effective anchorage depth $h_{ef} = 8 d^{1)}$							
Tension load	N [kN]	2,0	6,4	9,5	12,9	21,7	31,9	43,1	62,8
Displacement	δ_{NO} [mm]	0,1	0,15	0,15	0,15	0,15	0,25	0,25	0,25
Displacement	δ_{Nz} [mm]	0,3	0,45	0,45	0,45	0,45	0,75	0,75	0,75

¹⁾ Values for $8d \leq h_{ef} \leq 20d$
can be calculated:

$$\delta_{NO} = \delta_{NO1} \frac{h_{ef}}{8d}$$

δ_{NO1} for $h_{ef} = 8d$

$$\delta_{Nz} = \delta_{Nz1} \frac{h_{ef}}{8d}$$

δ_{Nz1} for $h_{ef} = 8d$

Table 10: Displacements of fischer anchor rods to shear load

Size		M6	M8	M10	M12	M16	M20	M24	M30
Temperature range I -40°C / + 80°C and temperature range II -40°C / +120°C									
Property class 5.8 / A4-50 / C-50									
Shear load	V [kN]	2,8	5,1	8,1	11,8	21,9	34,2	49,1	78,3
Displacement	δ_{V0} [mm]	0,7	0,9	1,2	1,4	2,0	2,4	2,6	3,7
Displacement	δ_{Vz} [mm]	1,2	1,4	1,7	2,1	2,9	3,7	4,1	5,6
Property class A4-70									
Shear load	V [kN]	3,2	5,9	9,3	13,5	25,2	39,3	56,4	89,9
Displacement	δ_{V0} [mm]	0,8	1,0	1,3	1,6	2,2	2,8	3,4	4,3
Displacement	δ_{Vz} [mm]	1,1	1,6	2,0	2,4	3,4	4,2	5,6	6,4
Property class C-70 ¹⁾									
Shear load	V [kN]	4,0	7,3	11,6	16,9	31,4	49,0	70,4	112,2
Displacement	δ_{V0} [mm]	1,0	1,3	1,7	2,0	2,8	3,5	4,2	5,3
Displacement	δ_{Vz} [mm]	1,4	2,0	2,5	3,0	4,2	5,3	6,3	8,0
Property class 8.8 / A4-80 / C-80									
Shear load	V [kN]	4,6	7,0	11,1	15,2	30,1	47,0	67,7	107,7
Displacement	δ_{V0} [mm]	1,0	1,2	1,6	1,9	2,8	3,3	3,6	5,1
Displacement	δ_{Vz} [mm]	1,6	1,9	2,3	2,9	4,0	5,1	5,6	7,7

¹⁾ $f_{uk} = 700 \text{ N/mm}^2$; $f_{yk} = 560 \text{ N/mm}^2$

fischer injection system FIS V

fischer anchor rods
Displacements

Annex 12

Table 11: Design of Bonded Anchors acc. to TR 029
Characteristic values to tension load for fischer internal threaded anchors RG MI

Size		M 8	M 10	M 12	M 16	M 20	
Steel failure							
Characteristic resistance with screw	$N_{Rk,s}$	Property-class 5.8 [kN]	19	29	43	79	123
		Property-class 8.8 [kN]	29	47	68	108	179
		Property-class A4 [kN]	26	41	59	110	172
		Property-class 70 C [kN]	26	41	59	110	172
Partial safety factor	$\gamma_{Ms,N}^{1)}$	Property-class 5.8 [-]	1,50				
		Property-class 8.8 [-]	1,50				
		Property-class A4 [-]	1,87				
		Property-class 70 C [-]	1,87				
Combined pullout and concrete failure							
Diameter for calculation	d_H [mm]	12	16	18	22	28	
Effective anchorage depth	h_{ef} [mm]	90	90	125	160	200	
Characteristic values in concrete C20/25 Intended use: dry and wet concrete							
Temperature range I (-40°C/+80°C) ³⁾	$N_{Rk,p}^0$ [kN]	30	40	50	75	115	
Temperature range II (-40°C/+120°C) ³⁾	$N_{Rk,p}^0$ [kN]	25	30	40	60	95	
Characteristic values in concrete C20/25 Intended use: flooded hole ⁵⁾							
Temperature range I (-40°C/+80°C) ³⁾	$N_{Rk,p}^0$ [kN]	25	35	50	60	95	
Temperature range II (-40°C/+120°C) ³⁾	$N_{Rk,p}^0$ [kN]	20	25	35	50	75	
Increasing factors for $N_{Rk,p}^0$	ψ_c	C25/30 [-]	1,05				
		C30/37 [-]	1,10				
		C35/45 [-]	1,15				
		C40/50 [-]	1,19				
		C45/55 [-]	1,22				
		C50/60 [-]	1,26				
Splitting failure							
Edge distance $c_{cr,sp}$ [mm]		$h / h_{ef} \geq 2,0$	$1,0 h_{ef}$				
		$2,0 > h / h_{ef} > 1,3$	$4,6 h_{ef} - 1,8 h$				
		$h / h_{ef} \leq 1,3$	$2,26 h_{ef}$				
Spacing	$s_{cr,sp}$ [mm]	$2c_{cr,sp}$					
Partial safety factor $\gamma_{Mp} = \gamma_{Mc} = \gamma_{Msp}^{1)}$ [-]		dry and wet	$1,5^{2)}$				
		flooded hole ⁵⁾	$1,8^{4)}$				

¹⁾In absence of other national regulations

²⁾The partial factor $\gamma_2 = 1,0$ is included

³⁾See Annex 2

⁴⁾The partial factor $\gamma_2 = 1,2$ is included

⁵⁾Only for coaxial cartridge 380ml, 400ml and 410ml

fischer injection system FIS V

Design of Bonded Anchors acc. to TR 029
fischer internal threaded anchors RG MI
Characteristic values to tension load

Annex 13

Table 12: Design of Bonded Anchors acc. to TR 029
Characteristic values to shear load for fischer internal threaded anchors RG MI

Size		M 8	M 10	M 12	M 16	M 20		
Steel failure without lever arm								
Characteristic resistance	$V_{Rk,s}$	Property	5.8 [kN]	9,2	14,5	21,1	39,2	62
		class	8.8 [kN]	14,6	23,2	33,7	62,7	90
		Property	A4 [kN]	12,8	20,3	29,5	54,8	86
		class 70	C [kN]	12,8	20,3	29,5	54,8	86
Partial safety factor	$\gamma_{Ms,V}$	Property	5.8 [-]	1,25				
		class	8.8 [-]	1,25			1,5	
		Property	A4 [-]	1,56				
		class 70	C [-]	1,56				
Steel failure with lever arm								
Characteristic bending moment	$M_{Rk,s}^0$	Property	5.8[Nm]	20	39	68	173	337
		class	8.8[Nm]	30	60	105	266	519
		Property	A4[Nm]	26	52	92	232	454
		class 70	C[Nm]	26	52	92	232	454
Partial safety factor	$\gamma_{Ms,V}$	Property	5.8 [-]	1,25				
		class	8.8 [-]	1,25				
		Property	A4 [-]	1,56				
		class 70	C [-]	1,56				
Concrete pryout failure								
Factor k in Equation (5.7) of Technical Report TR 029, Section 5.2.3.3		k [-]	2,0					
Partial safety factor		γ_{Mcp} ¹⁾ [-]	1,5 ²⁾					
Concrete edge failure		See Technical Report TR 029, Section 5.2.3.4						
Partial safety factor		γ_{Mc} ¹⁾ [-]	1,5 ²⁾					

¹⁾ In absence of other national regulations.

²⁾ The partial safety factor $\gamma_2 = 1,0$ is included.

fischer injection system FIS V

Design of Bonded Anchors acc. to TR 029
fischer internal threaded anchors RG MI
Characteristic values to shear load

Annex 14

Table 13: Displacement of internal threaded anchors RG MI to tension load

Size		M8	M10	M12	M16	M20
Temperature range I (-40°C / + 80°C)						
Tension load	N [kN]	11,9	13,8	19,8	29,8	69,4
Displacement	δ_{NO} [mm]	0,2	0,2	0,3	0,3	0,7
Displacement	δ_{Nco} [mm]	0,6	0,6	0,9	0,9	2,1
Temperature range II (-40°C / + 120°C)						
Tension load	N [kN]	9,9	11,9	15,8	23,8	37,7
Displacement	δ_{NO} [mm]	0,15	0,15	0,25	0,25	0,6
Displacement	δ_{Nco} [mm]	0,45	0,45	0,75	0,75	1,8

Table 14: Displacement of internal threaded anchors RG MI to shear load

Size		M8	M10	M12	M16	M20
Temperature range I -40°C / + 80°C and temperature range II -40°C / +120°C						
Shear load (property class 5.8)	V [kN]	5,1	8,1	11,8	21,9	34,2
Displacement	δ_{VO} [mm]	0,9	1,2	1,4	2,0	2,4
Displacement	δ_{Vco} [mm]	1,4	1,7	2,1	2,9	3,7
Shear load (property class 8.8)	V [kN]	7,0	11,1	16,2	30,1	47,0
Displacement	δ_{VO} [mm]	1,2	1,6	1,9	2,8	3,3
Displacement	δ_{Vco} [mm]	1,9	2,3	2,9	4,0	5,1
Shear load (property class A4-70)	V [kN]	5,9	9,3	13,5	25,2	39,3
Displacement	δ_{VO} [mm]	1,0	1,3	1,6	2,2	2,8
Displacement	δ_{Vco} [mm]	1,6	2,0	2,4	3,4	4,2
Shear load (property class C 70 ¹⁾)	V [kN]	7,3	11,6	16,9	31,4	49,0
Displacement	δ_{VO} [mm]	1,3	1,7	2,0	2,8	3,5
Displacement	δ_{Vco} [mm]	2,0	2,5	3,0	4,2	5,3

¹⁾ $f_{uk} = 700 \text{ N/mm}^2$; $f_{yk} = 560 \text{ N/mm}^2$

fischer injection system FIS V

fischer internal threaded anchors RG MI
Displacements

Annex 15

Table 15: Design of Bonded Anchors acc. to TR 029
Characteristic values to tension load for reinforcing bars⁴⁾

Size	$\emptyset d$	8	10	12	14	16	20	25	28
Steel failure									
Characteristic resistance	$N_{Rk,s}$ [kN]	28	44	63	85	111	173	270	339
Partial safety factor	$\gamma_{Ms,N}$ ¹⁾ [-]	1,4							
Combined pullout and concrete failure									
Diameter for calculation	d [mm]	8	10	12	14	16	20	25	28
Characteristic bond resistance in concrete C20/25									
Temperature range I ³⁾ (-40°C/+80°C)	$\tau_{Rk,ucr}$ [N/mm ²]	11,0	11,0	11,0	10,0	10,0	9,5	9,0	8,5
Temperature range II ³⁾ (-40°C/+120°C)	$\tau_{Rk,ucr}$ [N/mm ²]	9,5	9,5	9,0	8,5	8,5	8,0	7,5	7,0
Increasing factor for $\tau_{Rk,ucr}$	ψ_c								
	C25/30 [-]	1,05							
	C30/37 [-]	1,10							
	C35/45 [-]	1,15							
	C40/50 [-]	1,19							
	C45/55 [-]	1,22							
	C50/60 [-]	1,26							
Splitting failure									
Edge distance $c_{cr,sp}$ [mm]	$h / h_{ef} \geq 2,0$	$1,0 h_{ef}$							
	$2,0 > h / h_{ef} > 1,3$	$4,6 h_{ef} - 1,8 h$							
	$h / h_{ef} \leq 1,3$	$2,26 h_{ef}$							
Spacing	$s_{cr,sp}$ [mm]	$2 c_{cr,sp}$							
Partial safety factor	$\gamma_{Mp} = \gamma_{Mc} = \gamma_{Msp}$ ¹⁾ [-]	1,5 ²⁾							

¹⁾ In absence of other national regulations.

²⁾ The partial safety factor $\gamma_2 = 1,0$ is included

³⁾ See Annex 2

⁴⁾ The values given in Table 15 are valid for reinforcing bars B 500 B with $f_{uk} = 550$ N/mm² and $f_{yk} = 500$ N/mm². Other reinforcing bars have to be calculated according to TR 029, Equation (5.1).

fischer injection system FIS V

Design of Bonded Anchors acc. to TR 029
Reinforcing bars
Characteristic values to tension load

Annex 16

Table 16: Design of Bonded Anchors acc. to TR 029
Characteristic values to shear load for reinforcing bars¹⁾

Size	Ø d	8	10	12	14	16	20	25	28
Steel failure without lever arm									
Charac- teristic resistance	$V_{Rk,s}$ [kN]	13,8	21,6	31,1	42,4	55,3	87	135	170
Partial safety factor	$\gamma_{Ms,V}$ [-]	1,5							
Steel failure with lever arm									
Characte- ristic bending moment	$M_{Rk,s}^0$ [Nm]	33	65	112	178	265	518	1012	1422
Partial safety factor	$\gamma_{Ms,V}$ [-]	1,5							
Concrete pryout failure									
Factor k in Equation (5.7) of Technical Report TR 029, Section 5.2.3.3	k [-]	2,0							
Partial safety factor	$\gamma_{Mcp}^{2)}$ [-]	1,5 ³⁾							
Concrete edge failure									
See Technical Report TR 029, Section 5.2.3.4									
Partial safety factor	$\gamma_{Mc}^{2)}$ [-]	1,5 ³⁾							

¹⁾The values given in Table 16 are valid for reinforcing bars B 500 B with $f_{yk} = 550 \text{ N/mm}^2$ and $f_{yk} = 500 \text{ N/mm}^2$.
Other reinforcing bars have to be calculated according to TR 029, Equation (5.1).

²⁾ In absence of other national regulations.

³⁾ The partial safety factor $\gamma_2 = 1,0$ is included.

fischer injection system FIS V

Design of Bonded Anchors acc. to TR 029
Reinforcing bars
Characteristic values to shear load

Annex 17

Table 17: Displacements of reinforcing bars to tension load ¹⁾

Size	Ø d	8	10	12	14	16	20	25	28
Temperature range I -40°C / +80°C		Effective anchorage depth $h_{ef} = 8 d^{2)}$							
Tension load	N [kN]	7,7	11,0	15,8	19,5	25,5	37,9	51,7	76,3
Displacement	δ_{NO} [mm]	0,2	0,2	0,2	0,2	0,2	0,3	0,3	0,3
Displacement	$\delta_{N_{\infty}}$ [mm]	0,6	0,6	0,6	0,6	0,6	0,9	0,9	0,9
Temperature range II -40°C / +120°C		Effective anchorage depth $h_{ef} = 8 d^{2)}$							
Tension load	N [kN]	6,4	9,5	12,9	16,6	21,7	31,9	43,1	62,8
Displacement	δ_{NO} [mm]	0,15	0,15	0,15	0,15	0,15	0,25	0,25	0,25
Displacement	$\delta_{N_{\infty}}$ [mm]	0,45	0,45	0,45	0,45	0,45	0,75	0,75	0,75

¹⁾ The values given in Table 17 are valid for reinforcing bars B 500 B with $f_{uk} = 550 \text{ N/mm}^2$ and $f_{yk} = 500 \text{ N/mm}^2$. Other reinforcing bars have to be calculated according to TR 029, Equation (5.1).

²⁾ Values for $8d \leq h_{ef} \leq 20d$ can be calculated:

$$\delta_{NO} = \delta_{NO1} \frac{h_{ef}}{8d} \quad \delta_{NO1} \text{ for } h_{ef} = 8d$$

$$\delta_{N_{\infty}} = \delta_{N_{\infty 1}} \frac{h_{ef}}{8d} \quad \delta_{N_{\infty 1}} \text{ for } h_{ef} = 8d$$

Table 18: Displacements of reinforcing bars to shear load ¹⁾

Size	Ø d	8	10	12	14	16	20	25	28
Temperature range I -40°C / +80°C and temperature range II -40°C / +120°C									
Shear load	V [kN]	5,1	8,1	11,8	16,0	21,9	34,2	49,1	78,3
Displacement	δ_{VO} [mm]	0,9	1,2	1,4	0,7	2,0	2,4	2,6	3,7
Displacement	$\delta_{V_{\infty}}$ [mm]	1,4	1,7	2,1	1,2	2,9	3,7	4,1	5,6

¹⁾ The values given in Table 18 are valid for reinforcement bars B 500 B with $f_{uk} = 550 \text{ N/mm}^2$ and $f_{yk} = 500 \text{ N/mm}^2$. Other reinforcing bars have to be calculated according to TR 029, Equation (5.1).

fischer injection system FIS V

Reinforcing bars
Displacements

Annex 18

Table 19: Design of Bonded Anchors acc. to TR 029

Characteristic values to tension load for fischer rebar anchors FRA

Size		M12	M16	M20	M24
Steel failure					
Characteristic resistance	$N_{Rk,s}$ [kN]	63	111	173	270
Partial safety factor	$\gamma_{Ms,N}^{1)}$ [-]	1,4			
Combined pullout and concrete failure					
Diameter of calculation	d [mm]	12	16	20	25
Characteristic bond resistance in concrete C20/25					
Temperature range I ³⁾ (-40°C / +80°C)	$\tau_{Rk,ucr}$ [N/mm ²]	11,0	10,0	9,5	9,0
Temperature range II ³⁾ (-40°C / +120°C)	$\tau_{Rk,ucr}$ [N/mm ²]	9,0	8,5	8,0	7,5
Increasing factors for $\tau_{Rk,ucr}$	Ψ_c	C25/30 [-]	1,05		
		C30/37 [-]	1,10		
		C35/45 [-]	1,15		
		C40/50 [-]	1,19		
		C45/55 [-]	1,22		
		C50/60 [-]	1,26		
Splitting failure					
Edge distance $c_{cr,sp}$ [mm]	$h / h_{ef} \geq 2,0$	$1,0 h_{ef}$			
	$2,0 > h / h_{ef} > 1,3$	$4,6 h_{ef} - 1,8 h$			
	$h / h_{ef} \leq 1,3$	$2,26 h_{ef}$			
Spacing	$s_{cr,sp}$ [mm]	$2 c_{cr,sp}$			
Partial safety factor	$\gamma_{Mp} = \gamma_{Mc} = \gamma_{Msp}^{1)}$ [-]	$1,5^{2)}$			

¹⁾ In absence of other national regulations.

²⁾ The partial safety factor $\gamma_2 = 1,0$ is included

³⁾ See Annex 2

fischer injection system FIS V

Design of Bonded Anchors acc. to TR 029
fischer rebar anchor FRA
Characteristic values to tension load

Annex 19

Table 20: Design of Bonded Anchors acc. to TR 029
Characteristic values to shear load for fischer rebar anchors FRA

Size		M12	M16	M20	M24
Steel failure without lever arm					
Characteristic resistance	$V_{Rk,s}$ [kN]	30	55	86	124
Partial safety factor	$\gamma_{Ms,V}$ [-]	1,56			
Steel failure with lever arm					
Characteristic bending moment	$M_{Rk,s}^0$ [Nm]	92	233	454	785
Partial safety factor	$\gamma_{Ms,V}$ [-]	1,56			
Concrete pryout failure					
Factor k in Equation (5.7) of Technical Report TR 029, Section 5.2.3.3	k [-]	2,0			
Partial safety factor	$\gamma_{Mcp}^{1)}$ [-]	1,5 ²⁾			
Concrete edge failure					
Partial safety factor	$\gamma_{Mc}^{1)}$ [-]	1,5 ²⁾			

¹⁾ In absence of other national regulations.

²⁾ The partial safety factor $\gamma_2 = 1,0$ is included.

fischer injection system FIS V

Design of Bonded Anchors acc. to TR 029
fischer rebar anchor FRA
Characteristic values to shear load

Annex 20

Table 21: Displacements of fischer rebar anchors FRA to tension load

Size		M12	M16	M20	M24
Temperature range I -40°C / +80°C		Effective anchorage depth $h_{ef} = 8 d^{1)}$			
Tension load	N [kN]	15,8	25,5	37,9	51,7
Displacement	δ_{NO} [mm]	0,2	0,2	0,3	0,3
Displacement	$\delta_{N\infty}$ [mm]	0,6	0,6	0,9	0,9
Temperature range II -40°C / +120°C		Effective anchorage depth $h_{ef} = 8 d^{1)}$			
Tension load	N [kN]	12,9	21,7	31,9	43,1
Displacement	δ_{NO} [mm]	0,15	0,15	0,25	0,25
Displacement	$\delta_{N\infty}$ [mm]	0,45	0,45	0,75	0,75

¹⁾ Values for $8d \leq h_{ef} \leq 20d$ can be calculated:

$$\delta_{NO} = \delta_{NO1} \frac{h_{ef}}{8d}$$

δ_{NO1} for $h_{ef} = 8d$

$$\delta_{N\infty} = \delta_{N\infty 1} \frac{h_{ef}}{8d}$$

$\delta_{N\infty 1}$ for $h_{ef} = 8d$

Table 22: Displacements of fischer rebar anchors FRA to shear load

Size		M12	M16	M20	M24
Temperature range I -40°C / + 80°C and temperature range II -40°C / +120°C					
Shear load	V [kN]	11,8	21,9	34,2	49,1
Displacement	δ_{VO} [mm]	1,4	2,0	2,4	2,6
Displacement	$\delta_{V\infty}$ [mm]	2,1	2,9	3,7	4,1

fischer injection system FIS V

fischer rebar anchor FRA
Displacements

Annex 21

Table 23: Design of Bonded Anchors acc. to CEN/TS 1992-4: 2009
Characteristic values to tension load for fischer anchor rods

Size		M 6	M 8	M 10	M 12	M 16	M 20	M 24	M 30		
Steel failure											
Characteristic resistance $N_{Rk,s}$	Property class	5.8 [kN]	11	19	29	43	79	123	177	281	
		8.8 [kN]	16	30	47	68	126	196	282	449	
	stainless steel A4 and steel C	Property class	50 [kN]	11	19	29	43	79	123	177	281
			70 [kN]	14	26	41	59	110	172	247	393
		80 [kN]	16	30	47	68	126	196	282	449	
Partial safety factor $\gamma_{Ms,N}^1$	Property class	5.8 [-]	1,50								
		8.8 [-]	1,50								
	stainless steel A4 and steel C	Property class	50 [-]	2,86							
			70 [-]	1,50 ³⁾ /1,87							
		80 [-]	1,60								
Combined pullout and concrete cone failure											
Diameter of calculation	d [mm]	6	8	10	12	16	20	24	30		
Characteristic bond resistance in concrete C20/25. Intended use: dry and wet concrete											
Temperature range I ⁴⁾	$\tau_{Rk,ucr}$ [N/mm ²]	9	11	11	11	10	9,5	9,0	8,5		
Temperature range II ⁴⁾	$\tau_{Rk,ucr}$ [N/mm ²]	6,5	9,5	9,5	9,0	8,5	8,0	7,5	7,0		
Characteristic bond resistance in concrete C20/25. Intended use: flooded hole⁶⁾											
Temperature range I ⁴⁾	$\tau_{Rk,ucr}$ [N/mm ²]	—	—	—	9,5	8,5	8,0	7,5	7,0		
Temperature range II ⁴⁾	$\tau_{Rk,ucr}$ [N/mm ²]	—	—	—	7,5	7,0	6,5	6,0	6,0		
Factor for uncracked concrete	k_{ucr} [-]	10,1									
Increasing factors for $\tau_{Rk,ucr}$	ψ_c	C25/30 [-]	1,05								
		C30/37 [-]	1,10								
		C35/45 [-]	1,15								
		C40/50 [-]	1,19								
		C45/55 [-]	1,22								
		C50/60 [-]	1,26								
Splitting failure											
Edge distance $C_{cr,sp}$ [mm]		$h / h_{ef} \geq 2,0$	1,0 h_{ef}								
		$2,0 > h / h_{ef} > 1,3$	4,6 h_{ef} - 1,8 h								
		$h / h_{ef} \leq 1,3$	2,26 h_{ef}								
Spacing	$s_{cr,sp}$ [mm]	2 $c_{cr,sp}$									
Partial safety factor	dry and wet	1,5 ²⁾									
$\gamma_{MP} = \gamma_{MC} = \gamma_{Msp}^1$ [-]	flooded hole ⁶⁾	1,8 ⁵⁾									

¹⁾In absence of other national regulations

⁵⁾The partial factor $\gamma_2 = 1,2$ is included

²⁾The partial factor $\gamma_2 = 1,0$ is included

⁶⁾Only for coaxial cartridge 380ml, 400ml and 410ml

³⁾For steel C: $f_{uk} = 700$ N/mm²; $f_{yk} = 560$ N/mm²

Displacements see Annex 12

⁴⁾See Annex 2

fischer Injections system FIS V

Design of Bonded Anchors acc. to CEN/TS 1992-4: 2009
fischer anchor rods
Characteristic values to tension load

Annex 22

Table 24: Design of Bonded Anchors acc. to CEN/TS 1992-4: 2009
Characteristic values to shear load for fischer anchor rods

Size		M6	M8	M10	M12	M16	M20	M24	M30		
Steel failure without lever arm											
Characteristic resistance $V_{Rk,s}$	Property class	5.8 [kN]	5	9	15	21	39	61	89	141	
		8.8 [kN]	8	15	23	34	63	98	141	225	
	stainless steel A4 and steel C	Property class	50 [kN]	5	9	15	21	39	61	89	141
			70 [kN]	7	13	20	30	55	86	124	197
		80 [kN]	8	15	23	34	63	98	141	225	
Steel failure with lever arm											
Characteristic bending moment $M_{Rk,s}^0$	Property class	5.8 [Nm]	8	19	37	65	166	324	561	1124	
		8.8 [Nm]	12	30	60	105	266	519	898	1799	
	stainless steel A4 and steel C	Property class	50 [Nm]	8	19	37	65	166	324	561	1124
			70 [Nm]	11	26	52	92	233	454	785	1574
		80 [Nm]	12	30	60	105	266	519	898	1799	
Ductility factor	k_2 [-]	0,8									
Partial safety factor steel failure											
$\gamma_{Ms,v}^{1)}$	Property class	5.8 [-]	1,25								
		8.8 [-]	1,25								
	stainless steel A4 and steel C	Property class	50 [-]	2,38							
			70 [-]	1,25 ³⁾ / 1,56							
		80 [-]	1,33								
Concrete pryout failure											
Factor in Equation (5.7) of CEN/TS 1992-4-4 Section 6.3.3	k_3 [-]	2,0									
Partial safety failure	$\gamma_{Mcp}^{1)}$ [-]	1,5 ²⁾									
Concrete edge failure											
Partial safety failure	$\gamma_{Mc}^{1)}$ [-]	See CEN/TS 1992-4: Section 6.3.4									
		1,5 ²⁾									

¹⁾ In absence of other national regulations.

²⁾ The partial safety factor $\gamma_2 = 1,0$ is included.

³⁾ For steel C: $f_{uk} = 700 \text{ N/mm}^2$; $f_{yk} = 560 \text{ N/mm}^2$

Displacements see Annex 12.

fischer injection system FIS V

Design of Bonded Anchors acc. to CEN/TS 1992-4: 2009
fischer anchor rods
Characteristic values to shear load

Annex 23

English translation prepared by DIBt

Table 25: Design of Bonded Anchors acc. to CEN/TS 1992-4: 2009
Characteristic values to tension load for fischer internal threaded anchors RG MI

Size		M 8	M 10	M 12	M 16	M 20		
Steel failure								
Characteristic resistance with screw	$N_{Rk,s}$	Property-class	5.8 [kN]	19	29	43	79	123
			8.8 [kN]	29	47	68	108	179
		Property-class	A4 [kN]	26	41	59	110	172
			C [kN]	26	41	59	110	172
Partial safety factor	$\gamma_{Ms,N}^{1)}$	Property-class	5.8 [-]	1,50				
			8.8 [-]	1,50				
		Property-class	A4 [-]	1,87				
			C [-]	1,87				
Combined pullout and concrete failure								
Diameter for calculation	d_H [mm]	12	16	18	22	28		
Effective anchorage depth	h_{ef} [mm]	90	90	125	160	200		
Characteristic values in concrete C20/25. Intended use: dry and wet concrete								
Temperature range I (-40°C/+80°C) ³⁾	$N_{Rk,p}^0$ [kN]	30	40	50	75	115		
Temperature range II (-40°C/+120°C) ³⁾	$N_{Rk,p}^0$ [kN]	25	30	40	60	95		
Characteristic values in concrete C20/25. Intended use: flooded hole⁵⁾								
Temperature range I (-40°C/+80°C) ³⁾	$N_{Rk,p}^0$ [kN]	25	35	50	60	95		
Temperature range II (-40°C/+120°C) ³⁾	$N_{Rk,p}^0$ [kN]	20	25	35	50	75		
Factor for uncracked concrete	k_{ucr} [-]	10,1						
Increasing factors for $N_{Rk,p}^0$	ψ_c	C25/30 [-]	1,05					
		C30/37 [-]	1,10					
		C35/45 [-]	1,15					
		C40/50 [-]	1,19					
		C45/55 [-]	1,22					
		C50/60 [-]	1,26					
Splitting failure								
Edge distance $c_{cr,sp}$ [mm]		$h / h_{ef} \geq 2,0$	1,0 h_{ef}					
		$2,0 > h / h_{ef} > 1,3$	4,6 h_{ef} - 1,8 h					
		$h / h_{ef} \leq 1,3$	2,26 h_{ef}					
Spacing	$s_{cr,sp}$ [mm]	2 $c_{cr,sp}$						
Partial safety factor $\gamma_{Mp} = \gamma_{Mc} = \gamma_{Msp}^{1)}$ [-]		dry and wet	1,5 ²⁾					
		flooded hole ⁶⁾	1,8 ⁴⁾					

¹⁾In absence of other national regulations

²⁾The partial factor $\gamma_2 = 1,0$ is included

³⁾See Annex 2

⁴⁾The partial factor $\gamma_2 = 1,2$ is included

⁵⁾Only for coaxial cartridge 380ml, 400ml and 410ml

Displacements see 15

fischer injection system FIS V

Design of Bonded Anchors acc. to CEN/TS 1992-4: 2009
fischer internal threaded anchors RG MI
Characteristic values to tension load

Annex 24

Table 26: Design of Bonded Anchors acc. to CEN/TS 1992-4: 2009
Characteristic values to shear load for fischer internal threaded anchors RG MI

Size		M 8	M 10	M 12	M 16	M 20		
Steel failure without lever arm								
Characteristic resistance	$V_{Rk,s}$	Property	5.8 [kN]	9,2	14,5	21,1	39,2	62
		class	8.8 [kN]	14,6	23,2	33,7	62,7	90
		Property	A4 [kN]	12,8	20,3	29,5	54,8	86
		class 70	C [kN]	12,8	20,3	29,5	54,8	86
Partial safety factor	$\gamma_{Ms,V}$	Property	5.8 [-]	1,25				
		class	8.8 [-]	1,25			1,5	
		Property	A4 [-]	1,56				
		class 70	C [-]	1,56				
Steel failure with lever arm								
Characteristic bending moment	$M_{Rk,s}^0$	Property	5.8[Nm]	20	39	68	173	337
		class	8.8[Nm]	30	60	105	266	519
		Property	A4[Nm]	26	52	92	232	454
		class 70	C[Nm]	26	52	92	232	454
Ductility factor		k_2 [-]	0,8					
Partial safety factor	$\gamma_{Ms,V}$	Property	5.8 [-]	1,25				
		class	8.8 [-]	1,25				
		Property	A4 [-]	1,56				
		class 70	C [-]	1,56				
Concrete pryout failure								
Factor in Equation (27) CEN/TS 1992-4-4, Section 6.3.3		k_3 [-]	2,0					
Partial safety factor		$\gamma_{Mcp}^{1)}$ [-]	1,5 ²⁾					
Concrete edge failure								
Partial safety factor		$\gamma_{Mc}^{1)}$ [-]	1,5 ²⁾					

¹⁾ In absence of other national regulations.

²⁾ The partial safety factor $\gamma_2 = 1,0$ is included.

Displacements see annex 15.

fischer injection system FIS V	Annex 25
Design of Bonded Anchors acc. to CEN/TS 1992-4: 2009 fischer internal threaded anchors RG MI Characteristic values to shear load	

English translation prepared by DIBt

Table 27: Design of Bonded Anchors acc. to CEN/TS 1992-4: 2009
Characteristic values to tension load for reinforcing bars ⁴⁾

Size	Ø d	8	10	12	14	16	20	25	28
Steel failure									
Characteristic resistance	$N_{Rk,s}$ [kN]	28	44	63	85	111	173	270	339
Partial safety factor	$\gamma_{Ms,N}$ ¹⁾ [-]	1,4							
Combined pullout and concrete failure									
Diameter for calculation	d [mm]	8	10	12	14	16	20	25	28
Characteristic bond resistance in concrete C20/25									
Temperature range I ³⁾ (-40°C/+80°C)	$\tau_{Rk,ucr}$ [N/mm ²]	11,0	11,0	11,0	10,0	10,0	9,5	9,0	8,5
Temperature range II ³⁾ (-40°C/+120°C)	$\tau_{Rk,ucr}$ [N/mm ²]	9,5	9,5	9,0	8,5	8,5	8,0	7,5	7,0
Factor for uncracked concrete	k_{ucr} [-]	10,1							
Increasing factor for $\tau_{Rk,ucr}$	Ψ_c	1,05							
	C25/30 [-]	1,05							
	C30/37 [-]	1,10							
	C35/45 [-]	1,15							
	C40/50 [-]	1,19							
	C45/55 [-]	1,22							
	C50/60 [-]	1,26							
Splitting failure									
Edge distance $c_{cr,sp}$ [mm]	$h / h_{ef} \geq 2,0$	$1,0 h_{ef}$							
	$2,0 > h / h_{ef} > 1,3$	$4,6 h_{ef} - 1,8 h$							
	$h / h_{ef} \leq 1,3$	$2,26 h_{ef}$							
Spacing	$s_{cr,sp}$ [mm]	$2 c_{cr,sp}$							
Partial safety factor	$\gamma_{Mp} = \gamma_{Mc} = \gamma_{Msp}$ ¹⁾ [-]	1,5 ²⁾							

¹⁾ In absence of other national regulations.

²⁾ The partial safety factor $\gamma_2 = 1,0$ is included

³⁾ See Annex 2

⁴⁾ The values given in Table 27 are valid for reinforcing bars B 500 B with $f_{uk} = 550$ N/mm² and $f_{yk} = 500$ N/mm².
Other reinforcing bars have to be calculated according to equation:

$$N_{Rk,s} = A_s \cdot f_{uk} \text{ [N]}$$

$$\gamma_{Ms} = \frac{1,2}{f_{yk} / f_{uk}} \geq 1,4$$

Displacements see Annex 18.

fischer injection system FIS V

Design of Bonded Anchors acc. to CEN/TS 1992-4: 2009
Reinforcing bars
Characteristic values to tension load

Annex 26

Table 28: Design of Bonded Anchors acc. to CEN/TS 1992-4: 2009
Characteristic values to shear load for reinforcing bars ¹⁾

Size	Ø d	8	10	12	14	16	20	25	28
Steel failure without lever arm									
Charac- teristic resistance	$V_{Rk,s}$ [kN]	13,8	21,6	31,1	42,4	55,3	87	135	170
Partial safety factor	$\gamma_{Ms,V}$ [-]	1,5							
Steel failure with lever arm									
Characte- ristic bending moment	$M_{Rk,s}^0$ [Nm]	33	65	112	178	265	518	1012	1422
Ductility factor	k_2 [-]	0,8							
Partial safety factor	$\gamma_{Ms,V}$ [-]	1,5							
Concrete pryout failure									
Factor in Equation (27) CEN/TS 1992-4-4 Section 6.3.3	k_3 [-]	2,0							
Partial safety factor	γ_{Mcp} ²⁾ [-]	1,5 ³⁾							
Concrete edge failure									
See CEN/TS 1992-4, Section 6.3.4									
Partial safety factor	γ_{Mc} ²⁾ [-]	1,5 ³⁾							

¹⁾The values given in Table 28 are valid for reinforcing bars B 500 B with $f_{uk} = 550 \text{ N/mm}^2$ and $f_{yk} = 500 \text{ N/mm}^2$. Other reinforcing bars have to be calculated according to equation:

$$V_{Rk,s} = 0,5 \cdot A_s \cdot f_{uk} \text{ [N]}$$

$$\gamma_{Ms} = \frac{1,0}{f_{yk} / f_{uk}} \geq 1,25 \quad \text{for } f_{uk} \leq 800 \text{ N/mm}^2 \text{ and } f_{yk}/f_{uk} \leq 0,8$$

$$\gamma_{Ms} = 1,5 \quad \text{for } f_{uk} > 800 \text{ N/mm}^2 \text{ or } f_{yk}/f_{uk} > 0,8$$

²⁾ In absence of other national regulations.

³⁾ The partial safety factor $\gamma_2 = 1,0$ is included.

Displacements see Annex 18.

fischer injection system FIS V

Design of Bonded Anchors acc. to CEN/TS 1992-4: 2009
Reinforcing bars
Characteristic values to shear load

Annex 27

Table 29: Design of Bonded Anchors acc. to CEN/TS 1992-4: 2009
Characteristic values to tension load for fischer rebar anchors FRA

Size		M12	M16	M20	M24
Steel failure					
Characteristic resistance	$N_{Rk,s}$ [kN]	63	111	173	270
Partial safety factor	$\gamma_{Ms,N}^{1)}$ [-]	1,4			
Combined pullout and concrete failure					
Diameter of calculation	d [mm]	12	16	20	25
Characteristic bond resistance in concrete C20/25					
Temperature range I ³⁾ (-40°C / +80°C)	$\tau_{Rk,ucr}$ [N/mm ²]	11,0	10,0	9,5	9,0
Temperature range II ³⁾ (-40°C / +120°C)	$\tau_{Rk,ucr}$ [N/mm ²]	9,0	8,5	8,0	7,5
Factor for uncracked concrete	k_{ucr} [-]	10,1			
Increasing factors for $\tau_{Rk,ucr}$	Ψ_c	C25/30 [-]	1,05		
		C30/37 [-]	1,10		
		C35/45 [-]	1,15		
		C40/50 [-]	1,19		
		C45/55 [-]	1,22		
	C50/60 [-]	1,26			
Splitting failure					
Edge distance $c_{cr,sp}$ [mm]	$h / h_{ef} \geq 2,0$	$1,0 h_{ef}$			
	$2,0 > h / h_{ef} > 1,3$	$4,6 h_{ef} - 1,8 h$			
	$h / h_{ef} \leq 1,3$	$2,26 h_{ef}$			
Spacing	$s_{cr,sp}$ [mm]	$2 c_{cr,sp}$			
Partial safety factor	$\gamma_{Mp} = \gamma_{Mc} = \gamma_{Msp}^{1)}$ [-]	$1,5^{2)}$			

¹⁾ In absence of other national regulations.

²⁾ The partial safety factor $\gamma_2 = 1,0$ is included

³⁾ See Annex 2

Displacements see Annex 21.

fischer injection system FIS V

Design of Bonded Anchors acc. to CEN/TS 1992-4: 2009
fischer rebar anchor FRA
Characteristic values to tension load

Annex 28

Table 30: Design of Bonded Anchors acc. to CEN/TS 1992-4: 2009
Characteristic values to shear load for fischer rebar anchors FRA

Size		M12	M16	M20	M24
Steel failure without lever arm					
Characteristic resistance	$V_{Rk,s}$ [kN]	30	55	86	124
Partial safety factor	$\gamma_{Ms,V}$ [-]	1,56			
Steel failure with lever arm					
Characteristic bending moment	$M_{Rk,s}^0$ [Nm]	92	233	454	785
Partial safety factor	$\gamma_{Ms,V}$ [-]	1,56			
Ductility factor	k_2 [-]	0,8			
Concrete pryout failure					
Factor in Equation (27) CEN/TS 1992-4-4, Section 6.3.3	k_3 [-]	2,0			
Partial safety factor	$\gamma_{Mcp}^{1)}$ [-]	1,5 ²⁾			
Concrete edge failure					
Partial safety factor	$\gamma_{Mc}^{1)}$ [-]	See CEN/TS 1992-4, Section 6.3.4 1,5 ²⁾			

¹⁾ In absence of other national regulations.

²⁾ The partial safety factor $\gamma_2 = 1,0$ is included.

Displacements see Annex 21.

fischer injection system FIS V

Design of Bonded Anchors acc. to CEN/TS 1992-4: 2009
fischer rebar anchor FRA
Characteristic values to shear load

Annex 29